

Copyright (c) 2009 Elphel, Inc.
 Permission is granted to copy, distribute and/or modify this document
 under the terms of the GNU Free Documentation License, Version 1.3
 or any later version published by the Free Software Foundation;
 with no Invariant Sections, no Front-Cover Texts, and no Back-Cover Texts.
 A copy of the license is included in the section entitled "GNU
 Free Documentation License".

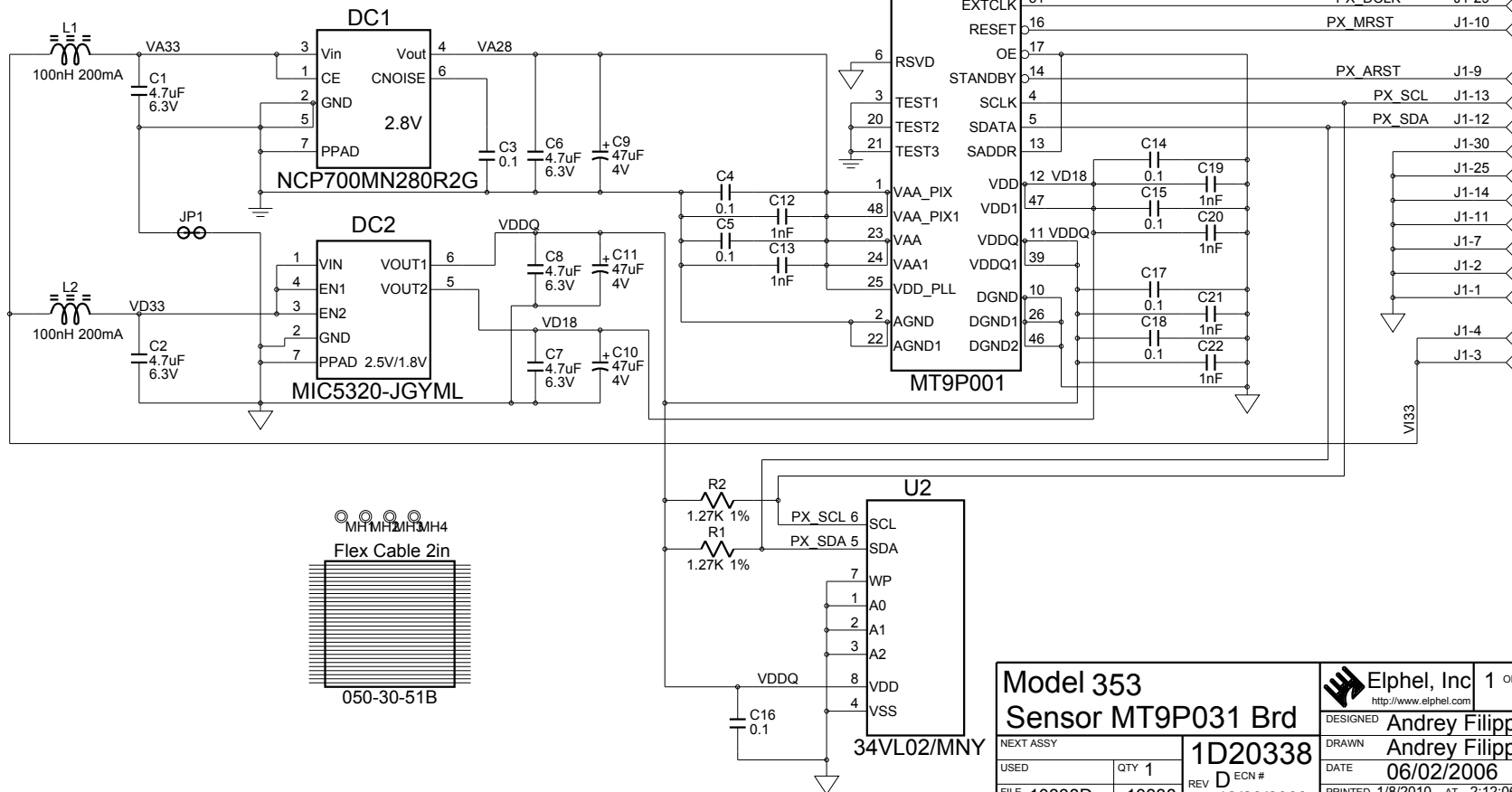

Model 353		Elphel, Inc 1 of 1 <small>http://www.elphel.com</small>	
Sensor MT9P031 Brd		DESIGNED Andrey Filippov	
NEXT ASSY	QTY 1	1D20338	DRAWN Andrey Filippov
USED	REV D ECN #	DATE 12/20/2009	DATE 06/02/2006
FILE 10338D	10338	DATE 12/20/2009	PRINTED 1/8/2010 AT 2:12:06 PM

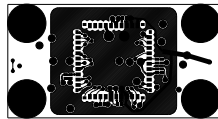

TOP SIDE (LAYER-1)			
	COMPONENT COPPER TOP (L-18)		



	GND PLANE (LAYER-2)		

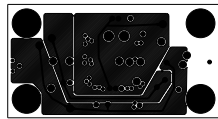

		PWR PLANE (LAYER-3)	

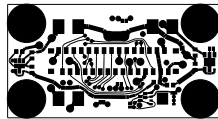

			BOTTOM SIDE (LAYER-4)
			COMPONENT COPPER BOTTOM (L-19)

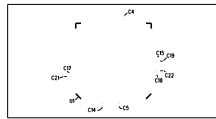

SILKSCREEN TOP			

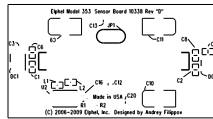

MOTTOB W3R92KJI			

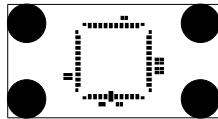

	SOLDER MASK TOP		

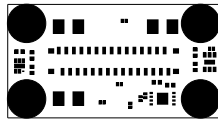

		SOLDER MASK BOTTOM	

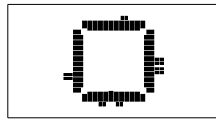

	PASTE MASK TOP		

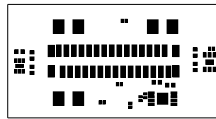

			PASTE MASK BOTTOM



DRILL DRAWING			

SIZE	QTY	SYM	PLTD
22	14	×	PLTD
8	25	⊗	PLTD
15	16	⊗	PLTD
9.84	2	B	PLTD
87	4	E	PLTD
32	2	N	PLTD